

CATÁLOGO

TEATROS/AUDITORIOS
E IGLESIAS
THEATERS/AUDITORIUMS
& CHURCHES



Sala Nezahualcóyotl

 **MOBILIARIO**
S.A. DE C.V.

Auditorio Nacional

Centro Cultural Roberto Cantoral

RESPALDOS/BACKS

Elige el respaldo que le dará nombre a tu butaca...

Choose the back that will name your seat...

Convention

Respaldo de poliuretano, espesor de 50 mm y 25 mm. Densidad 50 y 58 kg/m³. Acabado en Tela o Vinil. Polyurethane back, thickness 50mm & 25 mm. Density 50/58 kg/m³. Finished fabric or Vinyl.



Convention

Lumbar

Respaldo de poliuretano, espesor de 50 mm. Densidad 50 kg/m³. Acabado en Tela o Vinil. Polyurethane back, thickness 50mm. Density 50 kg/m³. Finished fabric or Vinyl.



Victoria

Respaldo de poliuretano, espesor de 50 mm. Densidad 50 kg/m³. Acabado en Tela o Vinil. Polyurethane back, thickness 50mm. Density 50 kg/m³. Finished fabric or Vinyl.



Lumiere

Respaldo de poliuretano, espesor de 50 mm. Densidad 50 kg/m³. Acabado en Tela o Vinil. Polyurethane back, thickness 50mm. Density 50 kg/m³. Finished fabric or Vinyl.



Retro

Respaldo de poliuretano, espesor de 50 mm y 25 mm. Densidad 50 y 58 kg/m³. Acabado en Tela o Vinil. Polyurethane back, thickness 50mm & 25 mm. Density 50/58 kg/m³. Finished fabric or Vinyl.



Delta

Respaldo de poliuretano, espesor de 50 mm y 25 mm. Densidad 50 y 58 kg/m³. Acabado en Tela o Vinil. Polyurethane back, thickness 50mm & 25 mm. Density 50/58 kg/m³. Finished fabric or Vinyl.



CODERA/ARMREST

CODERAS DE PLASTICO PLASTIC ARMREST



Codera STD Portavaso
STD Armrest Cupholder



Codera STD
STD Armrest



Codera Ancha Portavaso
Wide Armrest Cupholder

MESA ABATIBLE FOLDING TABLE



TEC



CODERAS DE MADERA WOOD ARMREST



Rollo/Scroll



longitudinal/longitudinal



Plana/Flat

CONVENTION H2



Inspirada en una butaca tradicional con un toque que la convierte en un sillón gracias a sus pedestales largos de polipropileno reciclables, los cuales harán que te olvides de rayaduras, corrosión y oxidación. Inspired in a traditional seat with a special touch that transforms it into a lounge due to its long recyclable polypropylene pedestals, which will make you forget scratches, corrosion and rust.

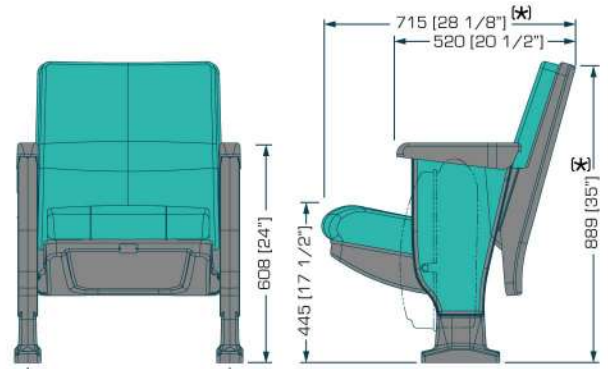

489 [19 1/4"] a/to 656 [22 1/4"]

CONVENTION T



La butaca tradicional y resistente que nunca pasa de moda gracias a su adaptabilidad en alturas y anchos nos permiten instalarla en toda clase de recintos, dándole un toque de elegancia y modernidad gracias a la variedad de tapicerías. The traditional and long lasting seat that never gets old fashion , due to its adaptability on heights & widths which allow a great installation in any kind of venue. The variety of upholstery provides a touch of elegance & modernity to the recinct.

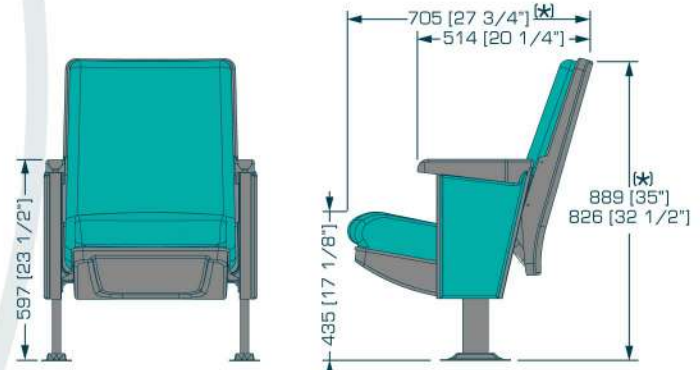

486 [19 1/8"] a/to 562 [22 1/8"]

CONVENTION OVAL 400



Un toque de elegancia y diseño en la butaca Convencional gracias a sus costados Ovalados 400 con plástico texturizado tipo piel y engalanado con un toque de tela a tu elección. An elegant design on a conventional seat given by its leather-like 400 Oval ends made of texturized hard plastic and dressed-up by an upholstery of your choice.



486 [19 1/8"] a/to 562 [22 1/8"]

DIMENSIONES TOMADAS CON LA ALTURA MAYOR
DIMENSIONS TAKEN FROM THE TALLEST BACK HEIGHT

⊗ Tolerancia/Tolerance: 6.35 [0.25"]
Unidades/Units: mm [in]

LUMIERE

OVAL 300

Si tu gusto es una butaca elegante y esbelta, los costados Oval 300 te permitirán la combinación perfecta. If an elegant & slim seat is of your taste, then the 300 Oval ends will allow you to have the perfect combination.

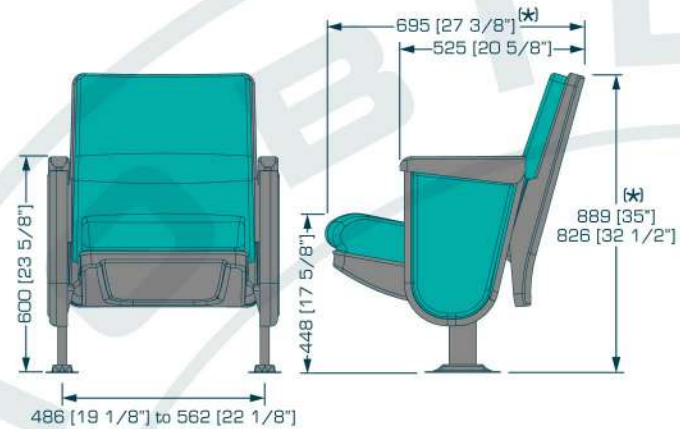

CONVENTION

COMPACT

Nunca hubieras imaginado que en un lugar angosto se pudiera amueblar con butacas. Nuestra Convention Compact con dimensiones especiales permite ser instalada en zonas estrechas; además de maximizar el aforo. You would have never imagined that a narrow place could be furnished with armchairs. Our Convention Compact with special dimensions can be installed in short areas besides maximizing the capacity of the venue.

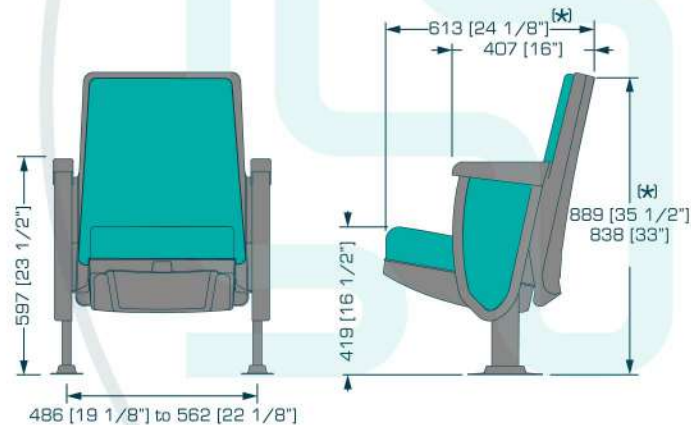

CONVENTION S

Porque la zona de reposo requiere de confort, el asiento "S" con curvas anatómicas te permitirán relajarte y descansar. Sus costados de diseño moderno serán la combinación perfecta. Because the resting area requires comfort, the "S" bottom seat with anatomical curves will allow you to relax and rest. Its standards with a modern design will be the perfect combination.



(*)Tolerancia/Tolerance: 6.35 [0.25"]
Unidades/Unites: mm [in]

DIMENSIONES TOMADAS CON LA ALTURA MAYOR
DIMENSIONS TAKEN FROM THE TALLEST BACK HEIGHT

CONVENTION LOVESEAT



Nuestro LoveSeat con brazos abatibles y tapa de centro acojinada te permitirán el aprovechamiento de espacios, mayor amplitud en las zonas de reposo y acercamiento con nuestros compañeros. Our Loveseat with flip-up armrests and cushioned center standard cover, will allow you to take advantage of all spaces, creating greater amplitude in the resting areas and closer environments with our companions.

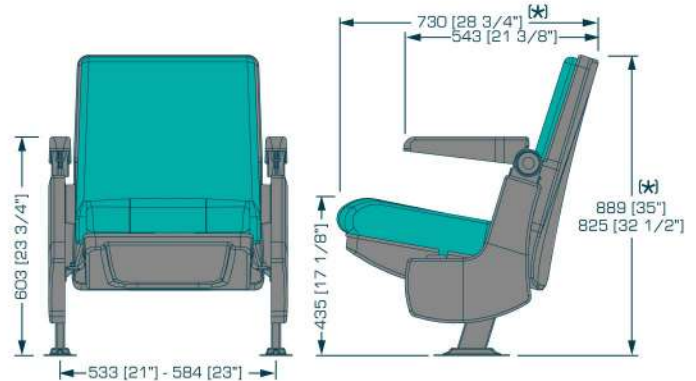

CONVENTION PEW/BANCA



La butaca sin límites se convierte ahora en una verdadera banca cómoda, sin brazos y con entre asientos alargados gracias a su tapa acojinada, excelente opción para recintos religiosos. The seat without limits now becomes a really comfortable pew, it comes without armrests which creates outstretched bottom seats due to its cushioned cap between seats, it is an excellent choice for places of worship.

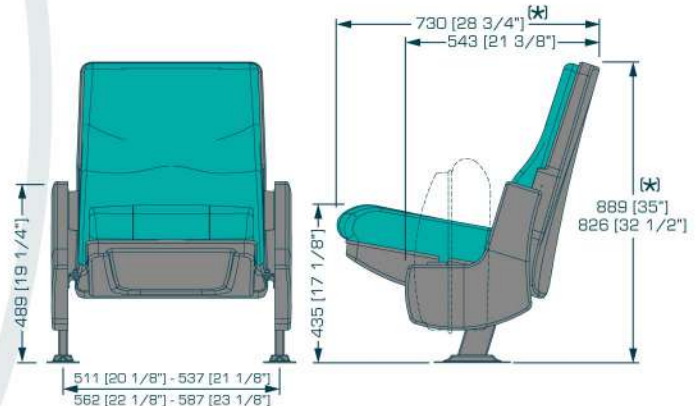

SCALA RT



Nuestra butaca Convencional se convierte en una pieza de diseño gracias a su pedestal curvo con brazo incluido fabricado en tubo redondo. Our conventional seat becomes a great piece of design due to its curved pedestal with armrest included, manufactured with rounded steel tube.

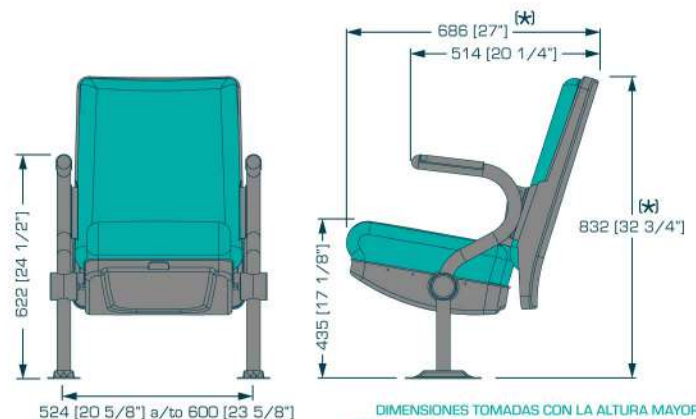

(*)Tolerancia/Tolerance: 6.35 [0.25"]
Unidades/Units: mm [in]

DIMENSIONES TOMADAS CON LA ALTURA MAYOR
DIMENSIONS TAKEN FROM THE TALLEST BACK HEIGHT

ROMA S-XT



Introduciéndonos en el arte moderno, Roma S-HPL hará que tu lugar sea único. Con sus pedestales plásticos estilizados y asientos contorneados que invitan a la gente a sentarse. Roma S-HPL hará que te olvides de la corrosión, oxidación y las rayaduras en la pintura. Falling in to the state of the art. Roma S-HPL will make your venue look unique. With stylish plastic pedestals and contoured seats that invite people to have a seat. Roma S-HPL will make you forget corrosion, oxidation and scratches in the paint.

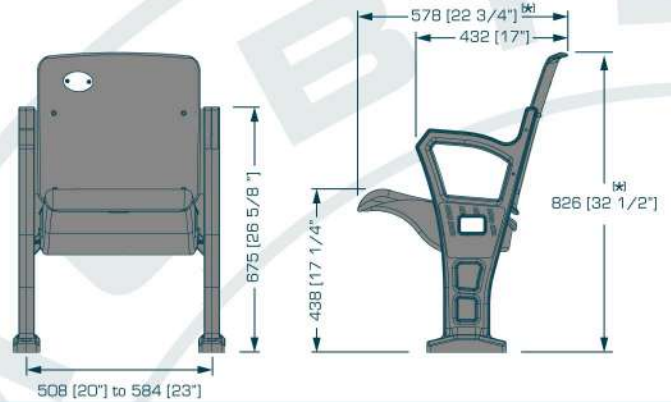

ROMA S

La butaca Roma más robusta y elegante gracias a sus pedestales rectangulares y su costado plástico con terminado tipo piel; además del asiento con mecanismo operado por gravedad libre de mantenimiento y durabilidad sin límite. Roma "S" is the most robust and elegant Roma Seat due to its rectangular pedestals and its plastic end leather-like finish; additionally it has a maintenance free bottom seat mechanism which is gravity operated. Durability without limits at your reach.

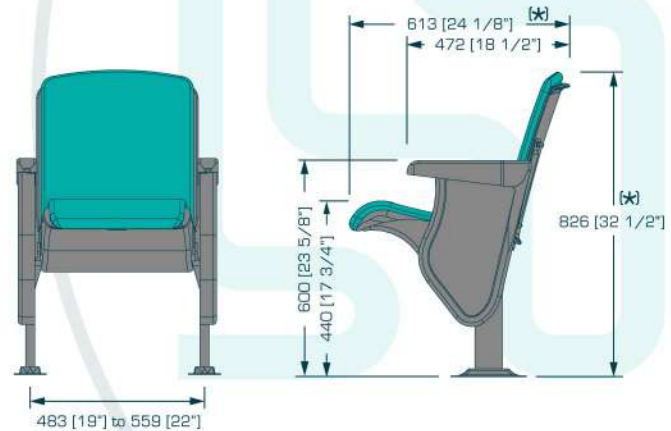

ROMA RT

Por su economía, esbeltez, diseño y curvas anatómicas en asiento, respaldo y pedestales es la mejor opción para llevar a su recinto confort y belleza. Disponible con y sin tapiz. For its accessibility, slenderness, design and anatomic curves in the bottom seat, backrest and standards, it is the best choice for bringing comfort and beauty to your venue. Available with or without upholstery.



(*)Tolerancia/Tolerance: 6.35 [0.25"]
Unidades/Units: mm [in]

499 [19 5/8"] 524 [20 5/8"] 549 [21 5/8"]

DIMENSIONES TOMADAS CON LA ALTURA MAYOR
DIMENSIONS TAKEN FROM THE TALLEST BACK HEIGHT

ROMA T

Nuestra Butaca Roma "T" con una variedad de opciones se encuentra disponible con costados de acero rectangular. Ideal para amueblar lugares reducidos, sin perder confort gracias a su anatomía en asiento y respaldo. Our Roma "T" seat is available with rectangular steel end standards. Ideal for furnishing small places, without losing comfort due to its anatomic shape in the bottom seat. Available on a wide range of upholstery and variety of colors.

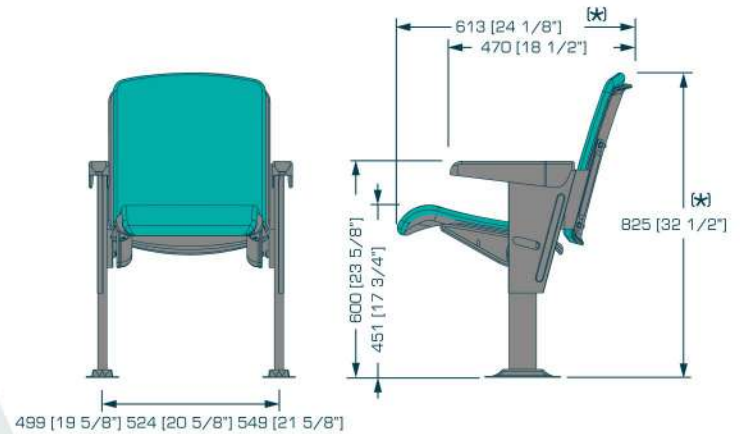

ALESSANDRIA E H2



La integración de curvas anatómicas del respaldo, asiento y costados se conjugan para brindar diseño y confort, las características de esta butaca te invitarán a permanecer sentado por largo tiempo, gozando de una experiencia de intensa comodidad. Este producto es vanguardista. The integration of anatomical curves of the back, bottom seat and end standards are combined to provide design and comfort, the characteristics of this chair will invite you to remain seated for long time, enjoying an intense experience of comfort. This is an avant-garde product.

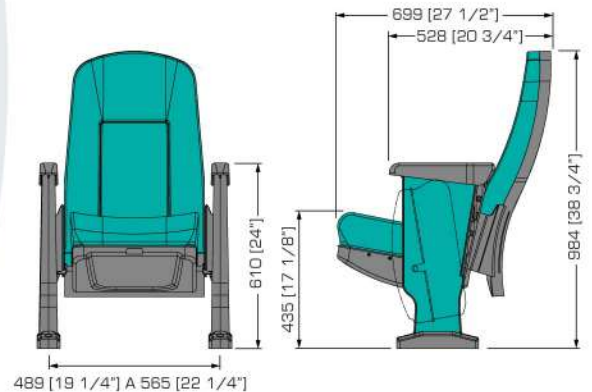

ALESSANDRIA T

Para permanecer sentado cómodamente, la espalda requiere de un excelente soporte lumbar. La butaca Alessandria fue diseñada elegantemente con curvas en el contra respaldo que te permiten disfrutar de eventos con gran duración. So as to sit comfortably, the back requires an excellent lumbar support, Alessandria T was elegantly designed with curves in the back that allow you to fully enjoy long duration events.

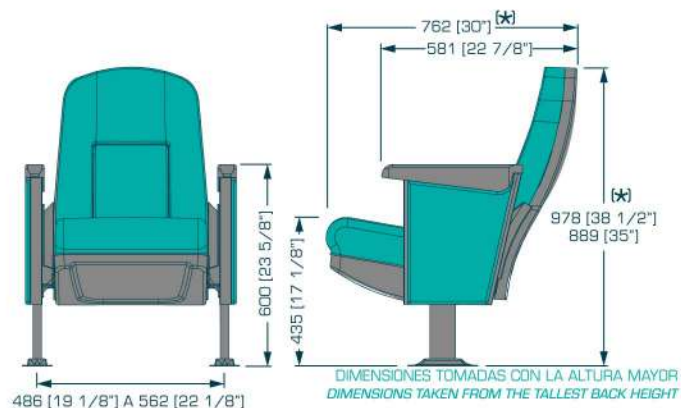

(*) Tolerancia/Tolerance: 6.35 [0.25"]
Unidades/Units: mm [in]

DIMENSIONES TOMADAS CON LA ALTURA MAYOR
DIMENSIONS TAKEN FROM THE TALLEST BACK HEIGHT

ALESSANDRIA

OVAL 400



La imaginación no tiene límite al convertir la butaca Alessandria en un producto de lujo y elegancia gracias a sus costados Oval 400.

Especialmente para auditorios con un toque de distinción y prestigio. Imagination has no limits when transforming the Alessandria armchair into a luxurious and elegant product with its Oval 400 end standards. Spectacular choice for auditoriums needing a touch of prestige & distinction.

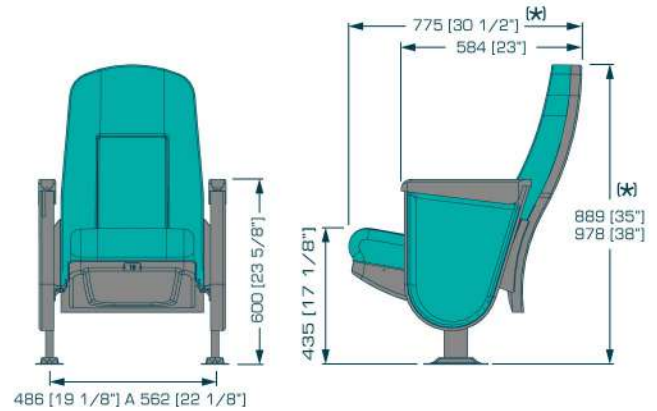

MARQUIS



Una butaca que cumple con las exigencias y gustos de todos los clientes, por su variedad en anchos, alturas del respaldo, brazos fijos o abatibles y sistema de respaldo fijo, rocker o swing. Juega con tu imaginación y adáptala a tus necesidades. A chair that meets the demands and tastes of all customers, due to the variety of widths, heights of the backrest, fixed or folding arms and Swing, rocker or fixed backrest system. Play with your imagination and adapt it to your needs.



(k) Tolerancia/Tolerance: 6.35 [0.25"]
Unidades/Units: mm [in]

DIMENSIONES TOMADAS CON LA ALTURA MAYOR
DIMENSIONS TAKEN FROM THE TALLEST BACK HEIGHT



Calle Del Sol 3, Col. San Rafael Chamapa,
C.P. 53660 Naucalpan de Juárez,
Estado de México.

CONTACTO
LADA SIN COSTO MEXICO 01800 288 6624
TELS.: 01 55 5300 0620 | FAX: 55 5300 2136
ventas@mobiliario.net
www.mobiliario.net

CONTACT
TOLL FREE (USA CANADA) 1 877 847 2127
INTERNATIONAL SALES: +(52)(55) 5300 0620
sales@mobiliarioseating.com
www.mobiliarioseating.com