



Estadio Azteca - Estadio León - Arena Ciudad de México - Estadio Teodoro Mariscal - Parque Kukulcán Alamo - Arena Monterrey - Estadio Tomateros - Autódromo Hermanos Rodríguez - Deportivo 18 de Marzo - Estadio Hidalgo - Estadio Corregidora - Estadio Victoria - Estadio Nemesio Díez - Toyota Field - Estadio Agustín Coruco Díaz - Estadio de Béisbol Monterrey - Estadio Corona - Estadio Emilio Ibarra Almada - Estadio Miguel Alemán Valdés - Progress Energy Park - Estadio Nelson Barrera Romellón - Estadio Olímpico Andrés Quintana Roo - Estadio Cuauhtémoc - Estadio Panamericano - Estadio Alfonso Lastras Ramírez - Estadio Francisco Villa - Estadio de Béisbol Beto Ávila - Estadio Azteca - Estadio León - Arena Ciudad de México - Estadio Teodoro Mariscal - Parque Kukulcán Alamo - Arena Monterrey - Estadio Tomateros - Autódromo Hermanos Rodríguez - Deportivo 18 de Marzo - Estadio Hidalgo - Estadio Corregidora - Estadio Victoria - Estadio Nemesio Díez - Toyota Field - Estadio Agustín Coruco Díaz - Estadio de Béisbol Monterrey - Estadio Corona - Estadio Emilio Ibarra Almada - Estadio Miguel Alemán Valdés - Progress Energy Park - Estadio Nelson Barrera Romellón - Estadio Olímpico Andrés Quintana Roo - Estadio Cuauhtémoc - Estadio Panamericano - Estadio Alfonso Lastras Ramírez - Estadio Francisco Villa - Estadio de Béisbol Beto Ávila - Estadio Azteca - Estadio León - Arena Ciudad de México - Estadio Teodoro Mariscal - Parque Kukulcán Alamo - Arena Monterrey - Estadio Tomateros - Autódromo Hermanos Rodríguez - Deportivo 18 de Marzo - Estadio Hidalgo - Estadio Corregidora - Estadio Victoria - Estadio Nemesio Díez - Toyota Field - Estadio Agustín Coruco Díaz - Estadio de Béisbol Monterrey - Estadio Corona - Estadio Emilio Ibarra Almada - Estadio Miguel Alemán Valdés - Progress Energy Park - Estadio Nelson Barrera Romellón - Estadio Olímpico Andrés Quintana Roo - Estadio Cuauhtémoc - Estadio Panamericano - Estadio Alfonso Lastras Ramírez - Estadio Francisco Villa - Estadio de Béisbol Beto Ávila

**ESTADIOS Y ARENAS**  
**ARENAS & STADIUM**  
**2020**



# Roma S-XT



Diseño compacto y ligero  
Compact Design & Light



Con portavasos  
With cupholder

\*No aplicar detergentes agresivos, cloro o químicos para su limpieza. (La omisión de este punto invalida la garantía del producto).



Radio mínimo de instalación 12 m.  
Minimo Radio Installation 12 m.

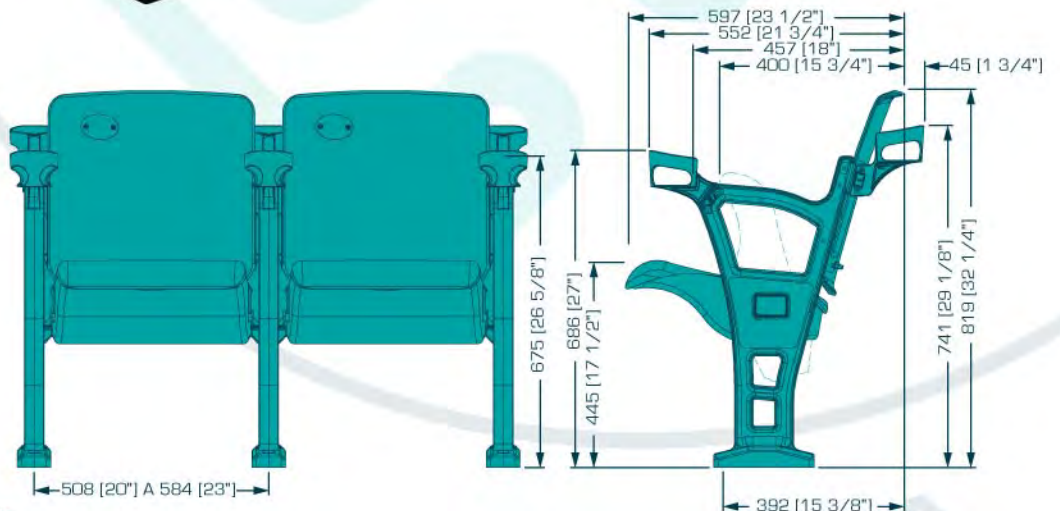

Dimensiones estándar, estas pueden variar por proyecto.  
Standard dimensions, these may vary by project.  
La imagen sólo es representativa, los colores pueden variar.  
The image is only representative, the colors can vary.  
MOBILIARIO se reserva el derecho de modificar las especificaciones del producto sin previo aviso.  
MOBILIARIO reserves the right to modify the characteristics of the product without notice.  
Los asientos necesitan aditivos especiales para algunos tipos de clima. Consulta con tu ejecutivo de ventas para un asesoramiento especializado.  
The seats need special additives, for some types of weather. Consult with your sales executive for specialized advice.

PRUEBA DE IMPACTO, DESGARRE Y FLEXION /ASTM F851-87  
PRUEBA DE ENVEJECIMIENTO /ASTM D3045-10  
PRUEBA DE UV /SAE J1960/SAE J2527 (FEB2004)  
PRUEBA DE COLOR /SAE J1767 (JAN2014)



MODELO  
**G4**

By Maglezmor

**Espacio para estampa de publicidad**  
(Optional)  
Space for sponsorship sticker  
(Optional)

**Ventana drenado**  
Drainage Gap

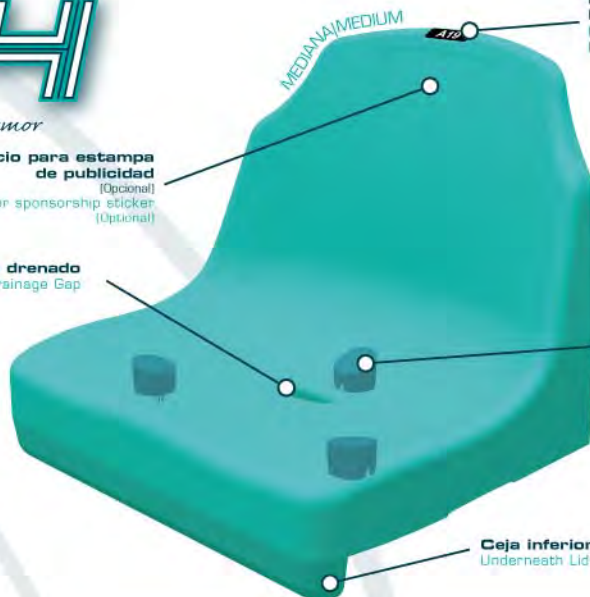

**Numeración**  
(Optional)  
Numbering Available  
(Optional)



**Fijación oculta con tapones plasticos**  
Hidden installation  
with plastic bolt caps.

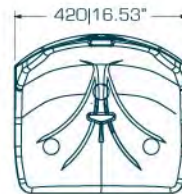

Acc.: mm./in.

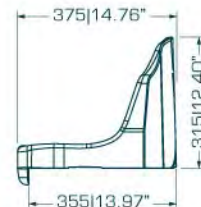
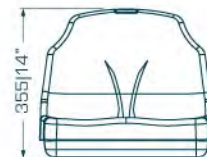

MODELO  
**G2**

By Maglezmor

**Espacio publicidad**  
(Optional)  
Sponsorship Insert  
(Optional)

**Ventana drenado**  
Drainage Gap

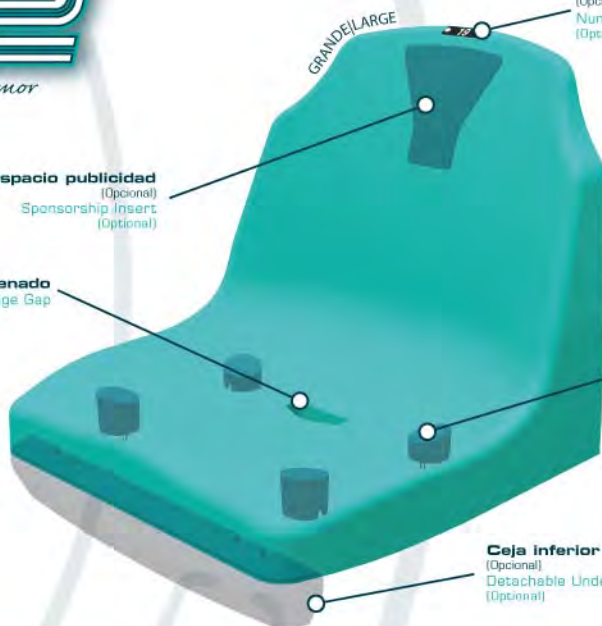

**Numeración**  
(Optional)  
Numbering Available  
(Optional)



**Fijación oculta con tapones plasticos**  
Hidden installation  
with plastic bolt caps.

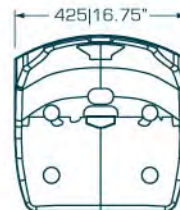

Acc.: mm./in.

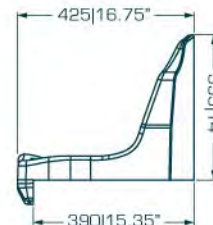
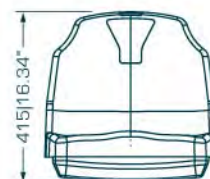

# Olympus

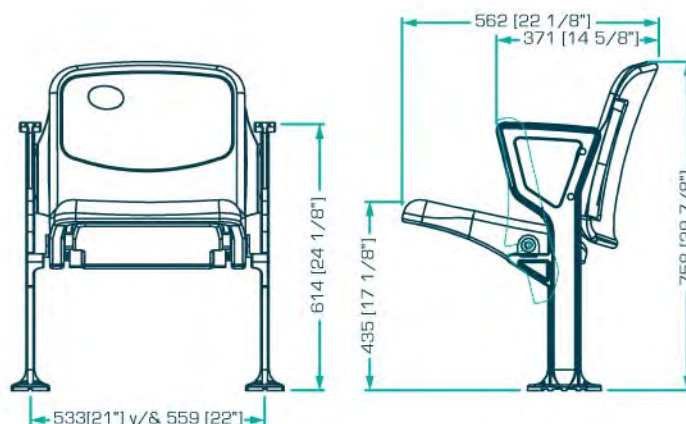

Dimensiones estándar, estas pueden variar por proyecto.  
Standard dimensions, these may vary by project.  
La imagen sólo es representativa, los colores pueden variar.  
The image is only representative, the colors can vary.  
MOBILIARIO se reserva el derecho de modificar las especificaciones del producto sin previo aviso.  
MOBILIARIO reserves the right to modify the characteristics of the product without notice.  
Los asientos necesitan aditivos especiales para algunos tipos de clima. Consulta con tu ejecutivo de ventas para un asesoramiento especializado.  
The seats need special additives, for some types of weather. Consult with your sales executive for specialized advice.

# Asientos Para Gradas/Bleacher Seats

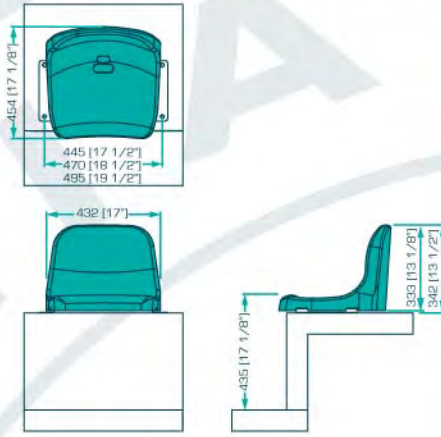

**Giovanni**

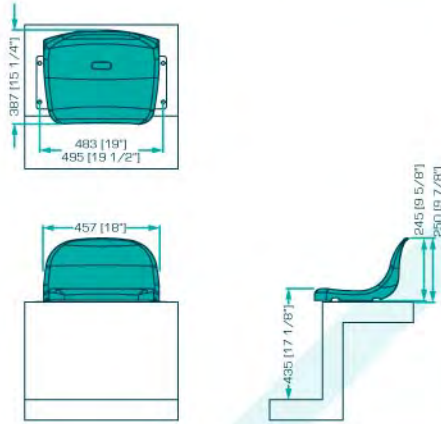

**Confort**

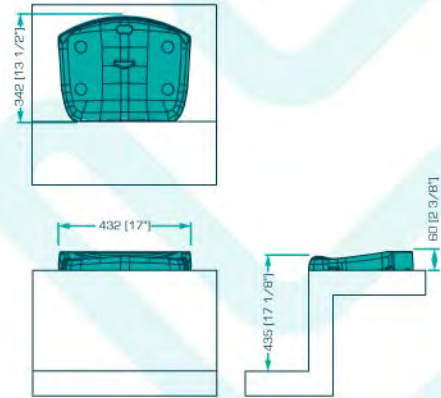

**Bambino**

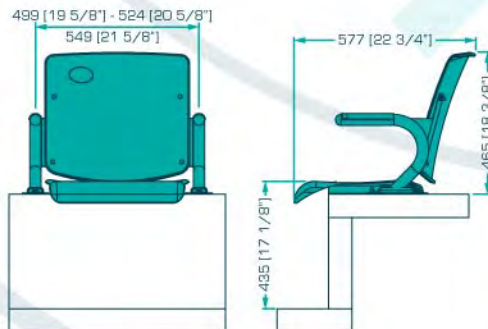

**Audi**

# Asientos Para Gradas/Bleacher Seats



**JG**

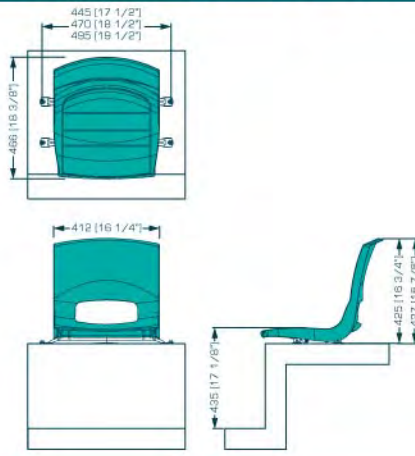

**Durable**

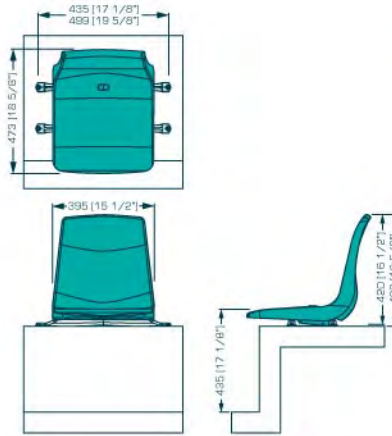

**2000**

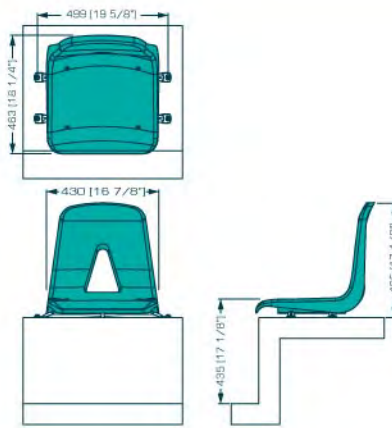

**AG**

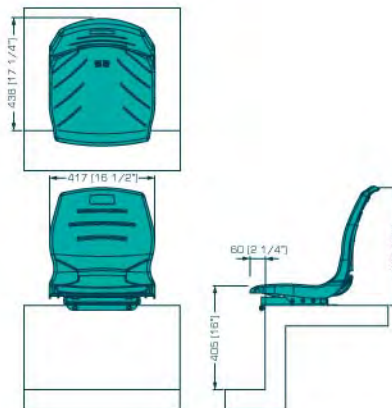

# Suites Y Banca De Jugadores/Suites & Players Bench



**Cobra**

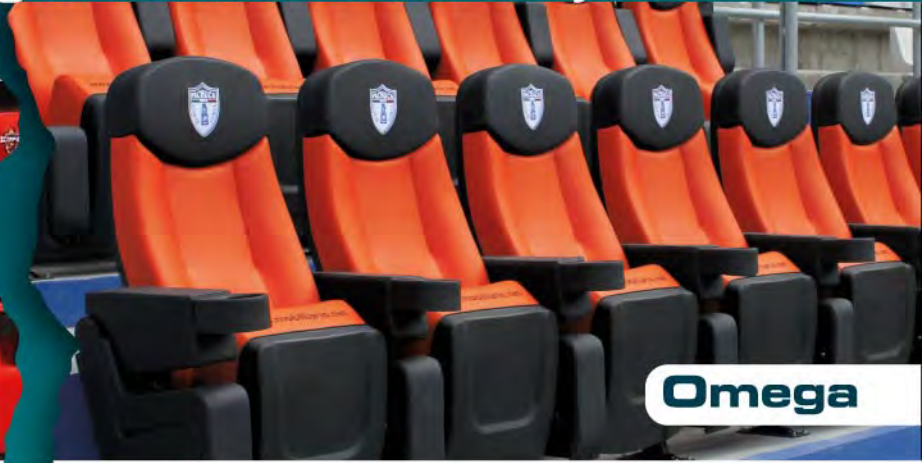

**Omega**



**Angela Plus**



**Alessandria "E"**



**Capri**



**Convention AL**

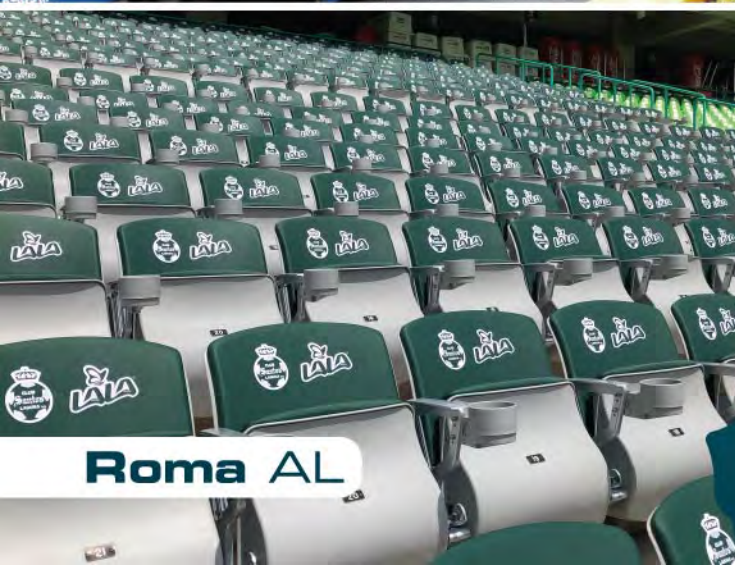

**Roma AL**



**Marquis**



## Moonlight

Ancho | **Width** 464 mm. | 18 1/4 in.  
 Profundidad | **Depth** 608 mm. | 24 in.  
 Altura | **Height** 950 mm. | 37 3/8 in.  
 Altura del piso al Asiento  
**Height From floor to Seat** 486 mm. | 19 1/8 in.



## Twilight

Ancho | **Width** 464 mm. | 18 1/4 in.  
 Profundidad | **Depth** 551 mm. | 21 5/8 in.  
 Altura | **Height** 840 mm. | 33 in.  
 Altura del piso al Asiento  
**Height from floor to Seat** 486 mm. | 19 1/8 in.



## SG

Ancho | **Width** 502 mm. | 19 3/4 in.  
 Profundidad | **Depth** 540 mm. | 21 1/4 in.  
 Altura | **Height** 762 mm. | 30 in.  
 Altura del piso al Asiento  
**Height from floor to Seat** 448 mm. | 17 5/8 in.

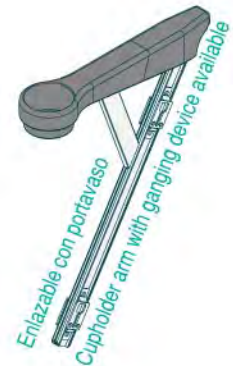

## CM

Ancho | **Width** 449 mm. | 17.68 in.  
 Profundidad | **Depth** 480 mm. | 18.89 in.  
 Altura | **Height** 796 mm. | 31.33 in.  
 Altura del piso al Asiento  
**Height from floor to Seat** 440 mm. | 17.32 in.

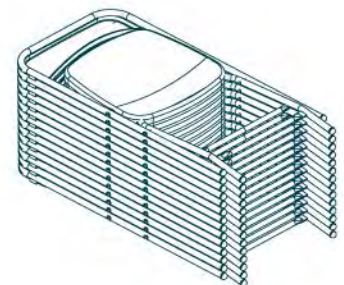

# Asientos Para Gradas/Bleacher Seats



**Cancún**

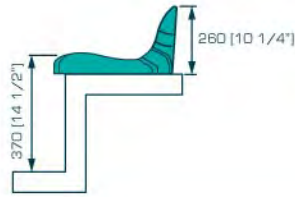
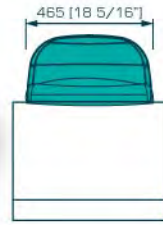
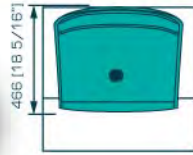

**Profile**

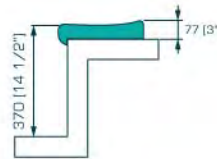
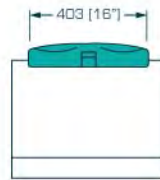
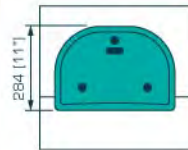

Calle Del Sol 3, San Rafael Chamapa,  
C.P. 53660. Naucalpan de Juárez,  
Estado de México.

CONTACTO  
LADA SIN COSTO MEXICO 01800 288 6624  
TELS.:01 55 5300 0620 | FAX: 55 5300 2136  
ventas@mobiliario.net  
www.mobiliario.net

CONTACT  
TOLL FREE (USA CANADA) 1 877 847 2127  
INTERNATIONAL SALES: +(52)(55) 5300 0620  
sales@mobiliarioseating.com  
www.mobiliarioseating.com